

Ref. Nr. 150.560



## **LED COLORLINE BAR LCB-384**

## **MANUAL**

Thank you for purchasing our company products.  
Please read these instructions carefully to enjoy optimum performance and a longer service life before you start to use.

**CONTENTS**

CONTENTS ..... 2

Unpacking Inspections ..... 3

    Unpacking instructions ..... 3

    Checking the contents of the carton: ..... 3

Safety Instructions ..... 3

Product Overview ..... 4

Functions Introductions ..... 4

    Main Functions ..... 4

    Operation Instructions ..... 4

        Power supply connecting : ..... 4

        Set parameter in the Action Mode ..... 5

        Set parameter in the System Setup mode: ..... 5

        Functions for Action mode and system setup mode : ..... 6

        Power supply by storage battery of Wi-Powerhouse ..... 6

        Master/Slave mode ..... 7

        Automatic ..... 7

        Controlled by DMX512 ..... 7

Maintenance ..... 10

Specification ..... 10

CE & R&TTE Declaration of Conformity ..... 11

p

## UNPACKING INSPECTIONS

### Unpacking instructions

- Please unpack the carton and check the goods carefully when you receive it , if discover packing damage, shortage or quality problem, please notify the shipper and reject the goods.
- Before using this product, please read the instructions carefully and keep it in a safe place for future reference.

### Checking the contents of the carton:

The product, Power cord, Instruction Manual, Mounting Braket \*2, Screws



## SAFETY INSTRUCTIONS

- Safety and regulatory power socket with high quality output should be used .
- Always connect the product to a grounded circuit to avoid the risk of electrocution.
- Never put tiny metal objects such as a screwdriver, iron wire and coins, etc. into the internal or stretch into the machine in case of short circuit .
- Please make sure to connect the proper voltage and do not higher or lower than that stated on the decal or rear panel of the product .
- Avoid hitting, crashing or squeezing with other objects in transportation. Never carry the product from the power cord or any moving part . Always use the hanging / mounting bracket or the handles.
- The product is used in door only .
- Never pull or tug on the cord and change it for another one , stop using it when it is damaged or becomes hot .
- Stop using the product once there is sparks when connecting with the power plug .
- Can not operate product with wet hands and never place it near the water or other liquid.
- Make sure there are no flammable materials close to the fixture while operating . Always install it in a location with adequate ventilation.
- Never replace the lighting source with different specification and rating when the original one is damaged.
- Make sure to power off before replacing the light source or the fuse. Never do it while it is on.
- The ambient temperature is no more than 40°C(104°F) .
- Never clean the fixture by water, thinner or other dissolved agent .
- Stop using the product in case of a serious operating problem and send it to our maintenance agent immediately. Never repair by non-professional workers .
- Avoid direct eye exposure to the light source while the product is on.

## PRODUCT OVERVIEW

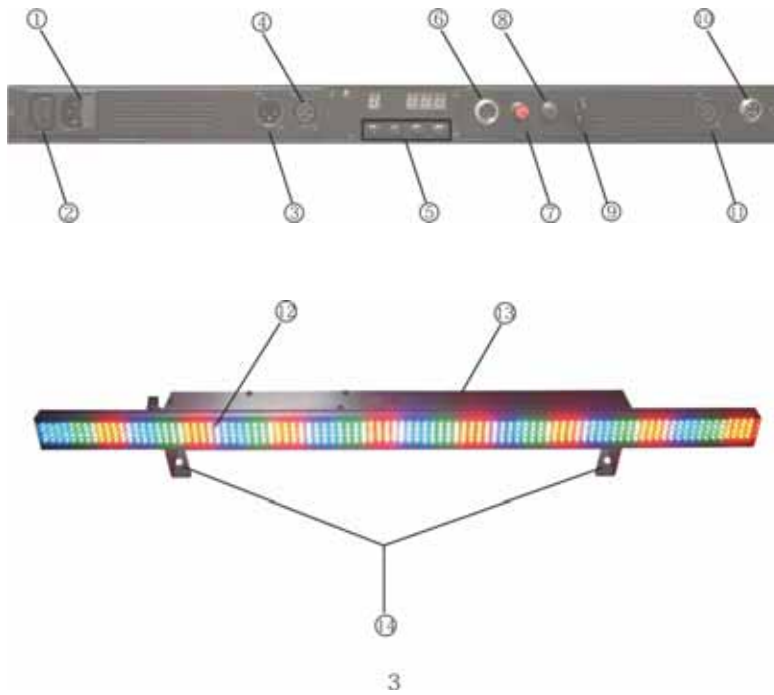

- |                                 |                                |
|---------------------------------|--------------------------------|
| 1. Power Input                  | 9. Safety Eyebolt              |
| 2. Power Output                 | 10. Four-pin Connector         |
| 3. DMX signal input             | 11. Master/Slave signal output |
| 4. DMX signal output            | 12. LEDs                       |
| 5. Control panel                | 13. Back Cover                 |
| 6. Six-pin Connector            | 14. Mounting Bracket           |
| 7. Sound Sensitivity Adjustment |                                |
| 8. Microphone                   |                                |

## FUNCTIONS INTRODUCTIONS

### Main Functions

- 4 DMX channels .
- Automatic, sound active, 32 units via master/slave mode .
- Built-in 23 actions, run speed and strobe speed can be adjusted .
- With static colors, strobe, dimmer, color mixing and changing effects .

### Operation Instructions

#### Power supply connecting :

Two sockets in the product, Power In and Power Out , the product can be supplied power by the power out. Maximum output power of the socket is 480W .

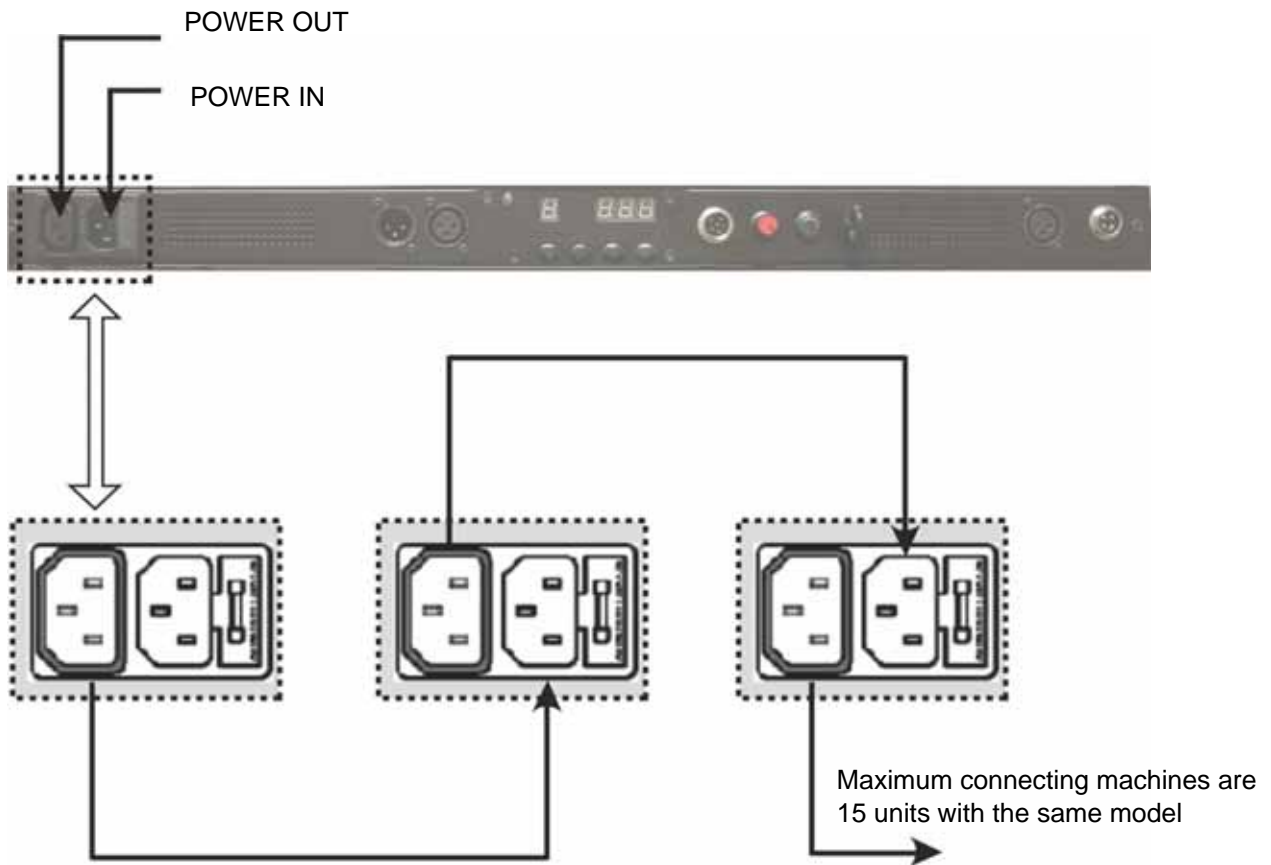

### Set parameter in the Action Mode

1. Power on until it resets ok and press Up or Down to display Act.
2. Press Enter and then press UP or Down to choose which kind of action mode you need.
3. Press Enter and then press UP or Down for adjustment , press Enter to the next parameter when there are many parameters .
4. Press Mode to exit .

Note: Digital means the parameters.

Axxx action mode.

Fxxx Flash Speed, F=000 no flash, F=100 Flash by sound.

Pxxx Run Speed, P=000 Stop running P=50 Fastest speed P=051-100 Sound Active.

A021 Digital means functions :

P000-P100, Red

F000-F100, Green

C000-C100, Blue

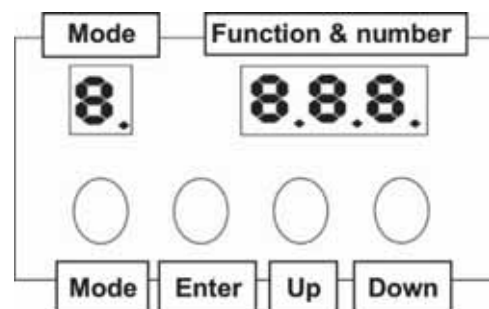

### Set parameter in the System Setup mode:

1. Power on until it resets ok and press Up or Down to display SYS .
2. Press Enter and then press UP or Down to choose which kind of parameter you need.
3. Press Enter and then press UP or Down to adjust .
4. Press Mode to exit .

Note :

When display S DAD and press Enter to set up DMX value .

When display S AAD and press Enter to display 8888, it resets ok with all light on.

5. Factory parameter Settings

With the factory parameter setting function, users can go back the factory parameter setting after adjusting by pressing the button of Mode for five seconds or so.

**Functions for Action mode and system setup mode :**

MODE	FUNC	PROGRAM	FUNTION/PROGRAM	(P)RUN SPEED	(F) FLASH SPEED	(C) COLOR		
ACt	A 000	000	Blackout					
		001	Red		000 – 100			
		002	Green		000 – 100			
		003	Blue		000 – 100			
		004	Yellow		000 – 100			
		005	Purple		000 – 100			
		006	Cyan		000 – 100			
		007	White		000 – 100			
		008	Color Change 1	Automatic 000-050		000 – 100		
		009	Color Change 2			000 – 100		
		010	Color Change 3			000 – 100		
		011	Color Change 4			000 – 100		
		012	Color Change 5					
		013	Color Change 6					
		014	Sequential Color Chase 1		Sound Active 051-100			
		015	Sequential Color Chase 2					
		016	Sequential Color Chase 3					
		017	Sequential Color Chase 4					
		018	Sequential Color Chase 5					
		019	Sequential Color Chase 6					
		020	Sequential Color Chase 7					
				021	RGB	Red (000-100)	Green (000-100)	Blue (000-100)
				022	Color Fader	000-100		
		023	Automatic Program (Sound)	001-100				
SYS	S dAd		DMX Channel Adressing	001-509				
	S Aad		RESET					

**Power supply by storage battery of Wi-Powerhouse**

The storage battery of the Wi-Powerhouse provide DC 12V can be connected through four-pin connector without other power supply when plug power 220V AC, the Wi-Powerhouse will stop supplying power .



**Master/Slave mode**

Connect the LCB-384 as below picture and power on all the connecting products. Control panel of master displays current saved mode and slave displays L005.L009.L013.Number of products connected can be shown on the slave control panel, slaves follow the actions of master.

Master/Slave connecting :

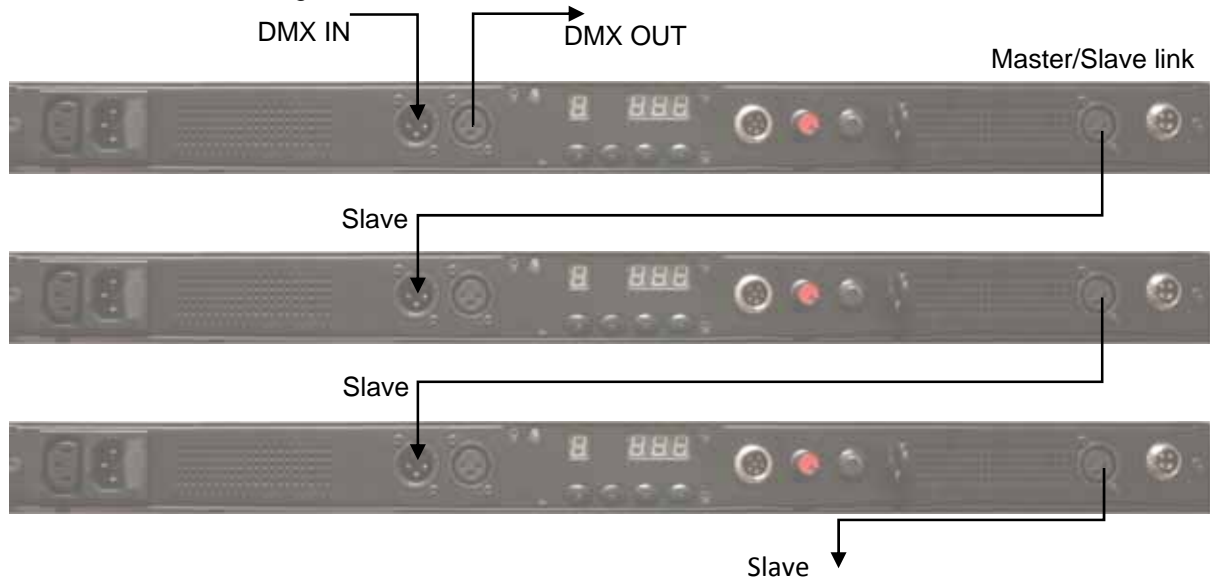

**Automatic**

LCB-384 will display current actions automatically without music or when sound sensitivity is turned off.

**Controlled by DMX512**

Follow below picture and power on all connected products. The products will be controlled once the address is set up.

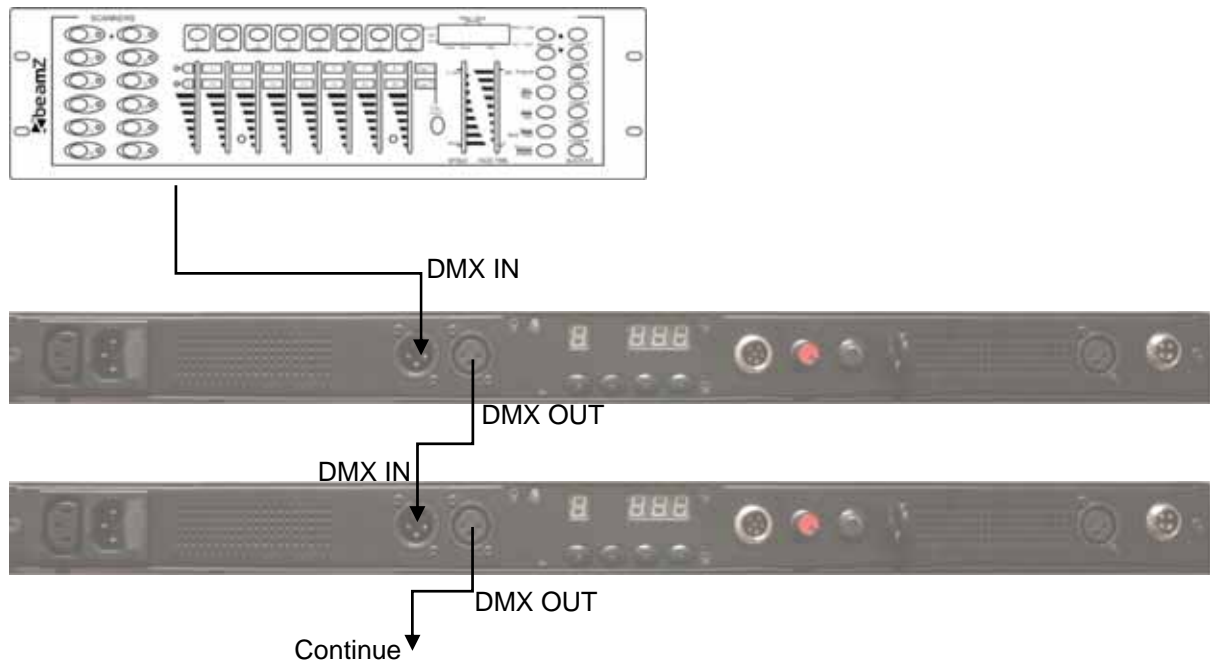

DMX512 signal is received and transmitted by the first product, the others follow the actions of the first one.

Master/Slave mode by DMX512:

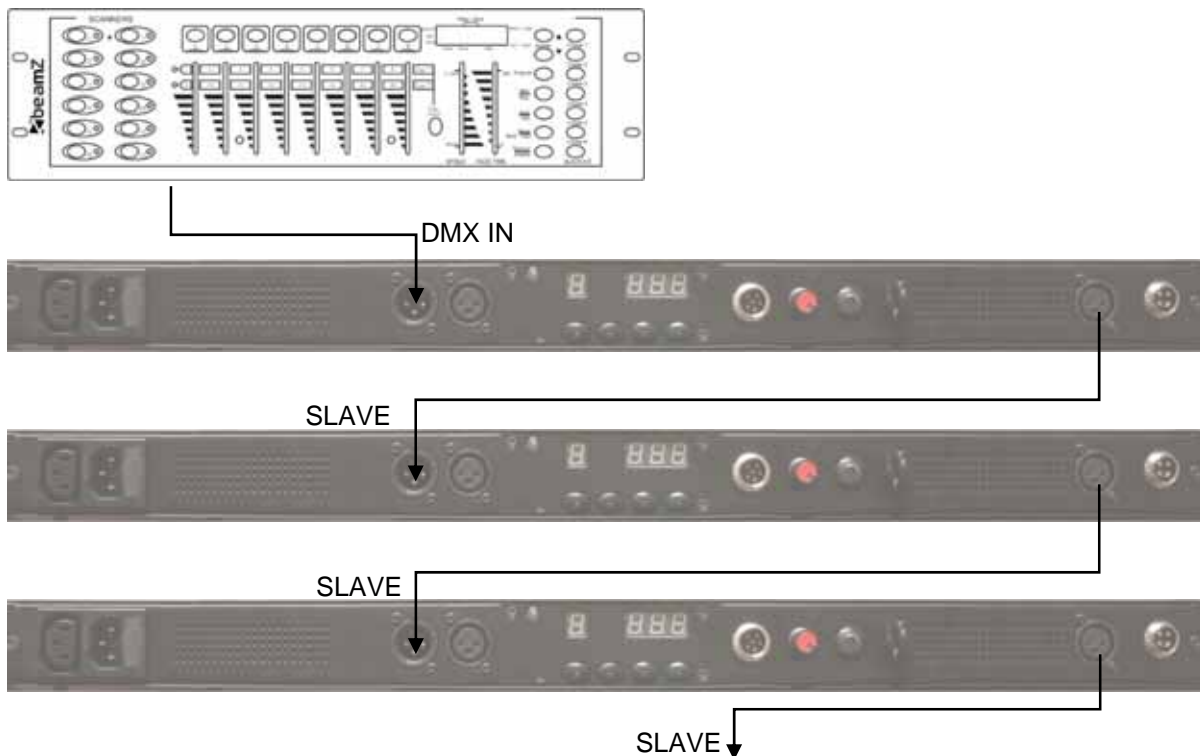

Multi-groups connecting with DMX

Wonderful colors and beautiful lighting effect can be displayed by multi-groups of products controlled by DMX512, DMX512 signal is received and transmitted by the the first product for each groups. Maximum connecting groups are 32.

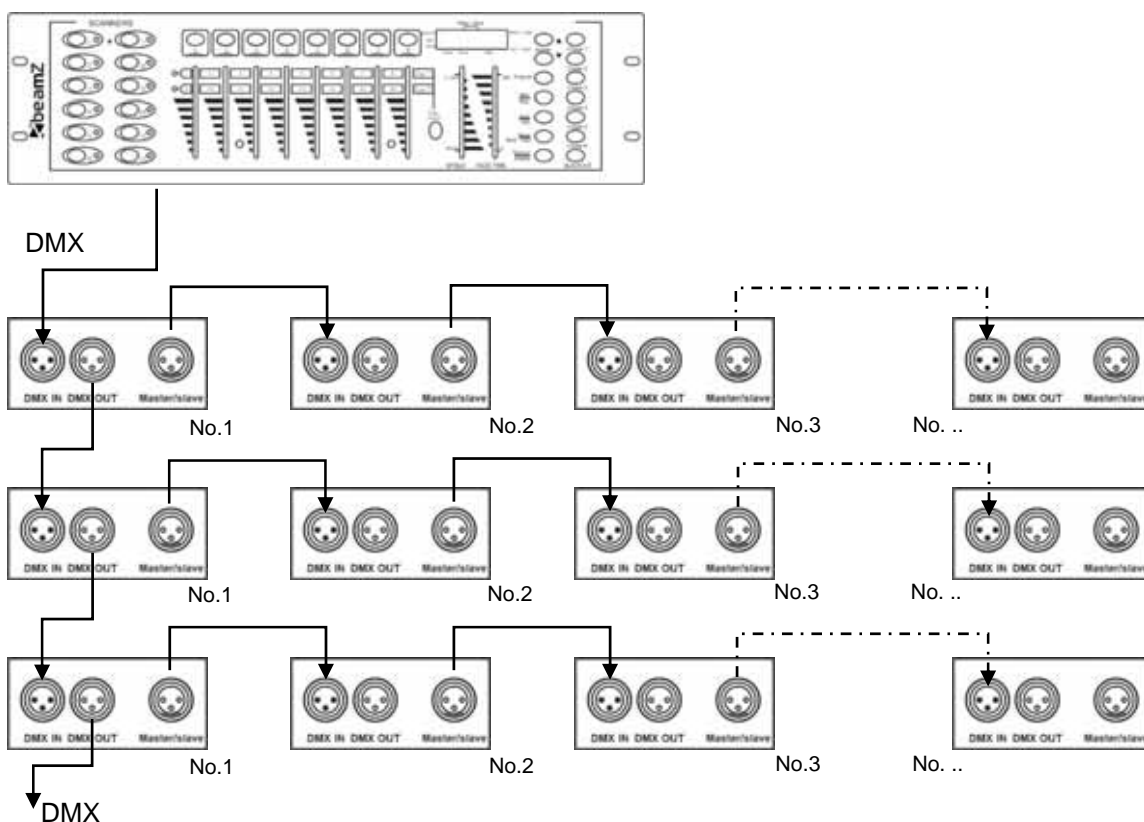

Operation Instructions for DMX512 :

In the mode of System setup, press Up or Down, and then choose “SDAD”to set up DMX value.

The channels for LCB-384 :



- CH1 Mode ( 0-23 )
- CH2 Run Speed ( 0-100% )
- CH3 Strobe Speed ( 0-100% )
- CH4 Color ( 0-100% )

DMX Value Functions

CHANNEL	VALUE	FUNCTION	CH 2	CH 3	CH 4
1		<b>Static colors</b>		Flash speed 000 – 249	
	000 – 009	Blackout			
	010 – 019	Red			
	020 – 029	Green			
	030 – 039	Blue			
	040 – 049	Yellow			
	050 – 059	Purple		Sound Active 249 – 255	
	060 – 069	Cyan			
	070 – 079	White			
		<b>Color Changes</b>		Flash speed 000 – 249	
	080 – 089	Color change 1	Run Speed  Automatic 000 – 127	Sound Active 249 – 255	
	090 – 099	Color change 2			
	100 – 109	Color change 3			
	110 – 119	Color change 4			
	120 – 129	Color change 5			
	130 – 139	Color change 6			
		<b>Sequential Color Chases</b>	Sound Active 128 – 255		
	140 – 149	Color chase 1			
	150 – 159	Color chase 2			
	160 – 169	Color chase 3			
	170 – 179	Color chase 4			
	180 – 189	Color chase 5			
	190 – 199	Color chase 6			
200 – 209	Color chase 7				
210 – 219	RGB Color Mix mode	Red 0-100%	Green 0-100%	Blue 0-100%	
220 – 229	Color Fade	Fade speed 0-100%			
230 – 255	Auto Run (sound active only)				

Note: CH1 DMX Value is 080-209, 230-255, CH2 000-127 for auto run speed,128-255 for sound active with music,auto display without music.

## MAINTENANCE

The unit should be cleaned periodically to ensure the optimum performance, the smudginess can decrease the life of light and the output of light is affected by the dust which can make the machine overheating. In general, make the maintenance at least two times a month. Be sure to power off the unit before cleaning .

Do not clean until the unit recovers normal temperature since high temperature for using, use the lens tissue or soft cotton cloth with alcohol to wipe gently.

Cleaning frequency depends on the environment in which the fixture operates, damp, smoky or dirty surrounding can cause greater accumulation of dirt on the optics. Never rub or press strongly on the panel.

## SPECIFICATION

Voltage..... 100-240V AC 50/60Hz  
Input current ..... 0.4A  
Power..... 32W  
Fuse.....2A 250V  
Light source .....384pcs LED  
..... 128 pcs red  
..... 128pcs green  
.....128pcs blue  
Beam Angle .....65° x 30°  
Weight.....2.5kg  
Size.....L965 x W90 x H120mm



tronios  
Sound & Light

## CE & R&TTE DECLARATION OF CONFORMITY

Importer: TRONIOS BV  
Bedrijvenpark Twente 415  
7602 KM - ALMELO

Tel : 0031546589299  
Fax : 0031546589298  
The Netherlands

Product number: **150.560**  
Product Description: Beamz, LCB-384 LED Colorline 1m DMX

Regulatory Requirement: EN 60598-1/-2-17:2009  
EN 62031:2008  
EN 61347-2-13:2007  
EN 55015:2006/A2:2009  
EN61547:2009  
EN 61000-3-2/-3-3

The product meets the requirements stated in the above mentioned Standards. This certificate does not cover the aspects that may be relevant such as performance and fitness for purpose.

Almelo,

10-03-2012

Signature:

Specifications and design are subject to change without prior notice..

**[www.tronios.com](http://www.tronios.com)**

Copyright © 2013 by TRONIOS the Netherlands